

READ AND SAVE THESE INSTRUCTIONS

WARNING: A risk of fire and electrical shock exists in all electrical appliances and may cause personal injury or death. Please follow all safety instructions.

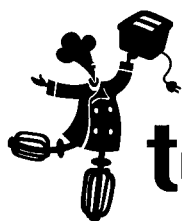

toastmaster[®]
cookin' in style



High Performance Electric Wok

Use and Care Guide - Model TWK45

- 4½ QUART CAPACITY
- NON-STICK COATED DIE CAST BODY
- ADJUSTABLE TEMPERATURE PROBE
- IMMERSIBLE WITH PROBE REMOVED

IMPORTANT SAFEGUARDS

When using electrical appliances, basic safety precautions should always be followed to reduce the risk of fire, electric shock and injury to persons, including the following:

- Read all instructions before using appliances.
- Do not touch hot surfaces. Use handles or knob.
- To protect against electrical shock, do not immerse cord, plug or Temperature Control Probe in water or other liquid. See instructions for cleaning.
- Close supervision is necessary when any appliance is used near children.
- This appliance is not for use by children.
- Unplug from outlet when not in use and before cleaning. Allow to cool before putting on or taking off parts and before cleaning the appliance.
- Do not operate any damaged appliance. Do not operate with a damaged cord or plug, or after the appliance malfunctions or has been dropped or damaged in any manner. Contact Consumer Service for return authorization, examination, repair or adjustment.
- The use of accessory attachments not recommended by the manufacturer may cause injuries.
- Do not use outdoors or while standing in a damp area.
- Do not let cord hang over edge of table or counter, or touch hot surfaces.
- Do not place on or near a hot gas or electric burner, or in a heated oven.
- Extreme caution must be used when moving a Wok containing hot oil or other hot liquids.
- Prior to connecting or disconnecting plug from wall outlet, turn Temperature Control Knob to "OFF." Always attach probe to the appliance first, then plug cord into wall outlet. To disconnect, remove plug from wall outlet first and then remove probe from the appliance.
- Do not use appliance for other than intended household use.

SAVE THESE INSTRUCTIONS

CAUTION: A short power supply cord is provided to reduce the risk of personal injury resulting from becoming entangled in or tripping over a longer cord. Extension cords are available from local hardware stores and may be used if care is exercised in their use. If an extension cord is required, special care and caution is necessary. Also the cord must be: (1) marked with an electrical rating of 125 V and at least 15 A, 1875 W, and (2) the cord must be arranged so that it will not drape over the countertop or tabletop where it can be pulled on by children or tripped over accidentally.

POLARIZED PLUG: This appliance has a polarized plug, (one blade is wider than the other). As a safety feature to reduce the risk of electrical shock, this plug is intended to fit in a polarized outlet only one way. If the plug does

not fit fully in the outlet, reverse the plug. If it still does not fit, contact a qualified electrician. Do not attempt to modify the plug in any way.

ELECTRIC POWER: If the electric circuit is overloaded with other appliances, your appliance may not operate properly. It should be operated on a separate electrical circuit from other appliances.

THIS PRODUCT IS FOR HOUSEHOLD USE ONLY

GETTING TO KNOW YOUR TOASTMASTER TWK45 HIGH PERFORMANCE ELECTRIC WOK

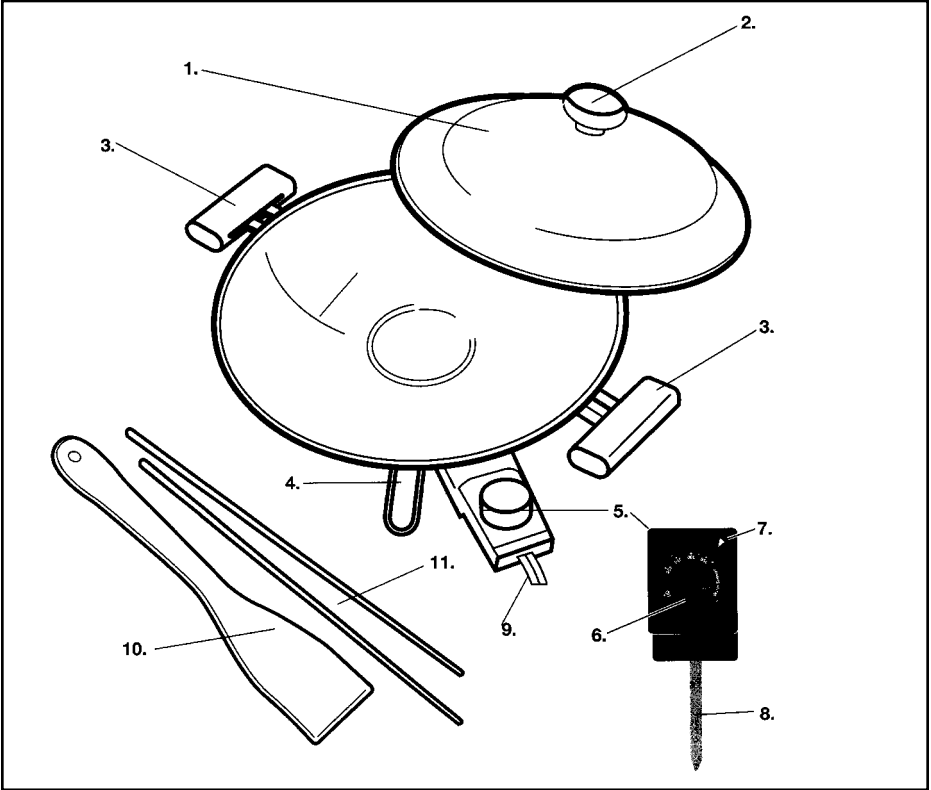

- | | |
|--------------------------------|------------------------------|
| 1. High Dome Cover | 6. Temperature Control Knob |
| 2. Wood Lid Knob | 7. Indicator Light |
| 3. Wood Handles | 8. Temperature Control Probe |
| 4. Stay-Cool Metal Base | 9. Power Cord |
| 5. Temperature Control w/Probe | 10. Wood Spatula |
| | 11. Chop Sticks |

INTRODUCTION

Congratulations on owning your Toastmaster Electric Wok.

Chinese cooking can be traced back 4,000 years, yet it continues to be in tune with today's American lifestyle. The marvels of modern technology incorporated in the Electric Wok will allow you to prepare a large variety of Asian recipes quickly and easily.

In the past, Chinese families cooked on small wood-burning stoves which produced a high intense flame that could be maintained for rapid continuous cooking. The Toastmaster Electric Wok provides the intense heat and a large cooking surface that traditional wok cooking demands.

The Wok's temperature is thermostatically controlled and adjustable from "WARM" to 400°F (200C). Fast heat recovery, so necessary for good wok cooking is achieved with its 1600 watts of power. The interior surface is coated with a unique non-stick coating that is "friendly to oil." It allows oil to form a patina on the surface, enabling the food to be properly cooked without sticking. The same coating is featured on the outside, too, making cleanup easy.

All the traditional oriental recipes are easily prepared in this Wok, but don't stop there. The Toastmaster Wok is so versatile that it can be used to prepare many favorite American and ethnic recipes. The Wok can be brought to the table for keeping food at serving temperature. Keep your Toastmaster Wok handy . . . it's a great addition to your kitchen.

BEFORE USING FOR THE FIRST TIME

Your new Toastmaster Electric Wok is coated inside and out with a specially formulated non-stick coating that is "friendly to oil." This means that cooking oil spreads evenly over the interior surface of your Electric Wok for perfect stir frying. Other non-stick coatings cause oil to puddle which is undesirable for wok cooking.

The interior of your Electric Wok may stain over time. Please be aware that this does not affect the non-stick characteristic of the coating or the cooking performance of the product.

Remove the Temperature Control Probe and wipe down with a soft, damp cloth. Set aside. The Wok is completely immersible. Wash Wok, Cover and Accessories with warm, sudsy water and rinse. Dry thoroughly before inserting the Temperature Control Probe. No preconditioning of the cooking surface is required.

INSTRUCTIONS FOR USE

1. The sturdy, stay-cool metal Base allows the Wok to be used for cooking on the kitchen counter and to be brought to the table for keeping food at serving temperature.
2. Organize and prepare all foods to be cooked.
3. Seasoning or conditioning the Wok surface before using is not required.
4. Set Knob on Temperature Control to "OFF." Insert Temperature Control Probe securely into Wok socket. Plug cord into 120 volt AC outlet. Always insert Temperature Control into Wok first, then insert plug into wall outlet.
5. If recipe calls for preheating, set Control Knob to desired temperature. When the Light on the Heat Control goes out, the selected temperature has been reached. During cooking, the Light will cycle on and off indicating that the Wok is maintaining the selected temperature.
6. When cooking and serving is completed, turn Temperature Control Knob to "OFF." Disconnect wall plug. Leave Temperature Control connected to Wok until cool.
7. **The Wok must be used with the Temperature Control provided. Do not use any other probe control or connector.**

TEMPERATURE CONTROL

The Temperature Control Probe is the nerve center and brain of the Wok. Treat it carefully. Dropping or banging it could change its calibration and make the temperature settings inaccurate.

Select the temperature as called for in the recipe. Allow Wok to cool before removing Control from the Wok.

To clean the Temperature Control Probe, simply wipe down with a soft, damp cloth. Make sure you dry it thoroughly before using again.

NOTE: The Temperature Control Probe is not immersible.

COVER

The aluminum High Dome Cover is loose fitting so steam can escape during simmering or steaming. ***For safety, the Cover should never be used while preheating or cooking with oil.*** (Water droplets on the inside of the Cover could fall into the oil, turn to steam, causing oil to splash.)

The inside of the Cover may discolor and become steam stained. Remove steam stains by scouring with steel wool soap pad. After each use, wash Cover in hot sudsy water, rinse and dry thoroughly.

COOKING TOOLS

The long wooden utensils designed specifically for the Toastmaster Wok are recommended. They will prevent scratching the surface. Do not use sharp-edged metal tools such as forks, knives, beaters, food choppers, etc., as they will scratch the surface.

Minor scratching of the non-stick surface will only affect the appearance of the Wok. It will not diminish the Wok's non-stick qualities nor affect food cooked in the Wok.

STEAMER RACK (NOT INCLUDED)

Steamer Racks may be purchased at many hardware, kitchenware, or general merchandise stores. A stainless steel folding steamer is recommended for use in your Toastmaster TWK45 Wok. Do not use sharp-edged metal steaming racks as they will scratch the surface.

When using a Steamer Rack:

1. Prepare foods to be steamed according to recipe.
2. Add 2 to 3 cups water to Wok. Water level should be about one inch below Rack.
3. Place Steamer Rack in Wok and place food on the Rack.
4. Set Temperature Control to 250°F (125°C) to keep water boiling. Cover with Wok Lid and steam according to the recipe. Add water as required.

USING MAINTENANCE INSTRUCTIONS

Cleaning

Disconnect plug from wall outlet and allow Wok to cool. Remove Temperature Control Probe and set aside. The Wok is completely immersible for cleaning. Wash the non-stick surface of the Wok thoroughly, inside and out, with hot, soapy water. Cooking oils that are not removed may become a rubbery, varnish-like substance that is difficult to remove. Do not use abrasive cleaners or abrasive pads.

Any servicing requiring disassembly other than the above cleaning must be performed by an authorized service representative. Contact Consumer Relations for further information.

Storage

The opening between the small wood Handle and the Wok Body can be used to hang the Wok. Care should always be taken to prevent the Wok from being scratched.

METHODS OF ASIAN COOKING

Before attempting any of the delicious recipes, take a few moments to understand the various methods that can be used in Asian cooking. Understanding the method will make preparing the recipe that much easier.

PRECONDITIONING (OPTIONAL)

Preconditioning is a step after food preparation and before actual cooking. It will help bring out the natural flavors. Blanching is a preconditioning that **helps shorten the final cooking time**. It's an extra step that will enhance the final results. Some preconditioning methods are:

Marinating

Food is soaked in a seasoned liquid mixture to gain extra flavor or to be tenderized.

Oil Blanching

Oil blanching is a form of frying at a low temperature and for a short period of time. Oil blanching is used in advance of stir frying and braising. This method separates the food, helps delicate ingredients retain their natural shape, prevents discoloration of certain foods and forms a light crust to seal in flavor.

220° F	Oil blanch delicate ingredients, such as sole and scallops.
275°F-300°F	Most foods are oil blanched and cook evenly at this temperature
375°F	Produces a light crust on food.

Gently lower food into preheated oil. When food changes color, usually one to two minutes, remove and drain. The oil temperature is determined by the type of food used.

Water Blanching

Partially cook vegetables in boiling water or chicken broth for about a minute. Tougher and fibrous vegetables, such as carrots and broccoli, may take a few minutes longer.

If preparing vegetables early in the day for later cooking, rinse vegetables under running cold water or plunge them into a bowl of cold water to stop the cooking action.

Preconditioning certain vegetables by water blanching will enable you to stir fry all the vegetables in the same amount of time with perfect results.

CUTTING METHODS

The Chinese people cut all their food with an eye for appearance. A different shape is planned for each ingredient. Cutting food into small pieces will also speed the cooking time. Food should always be cut in bite-sized pieces because knives are never used while eating. A sharp knife or a Chinese cleaver makes slicing easier.

Straight Slice

A straight slice is used for slicing meats and tender vegetables such as peppers and mushrooms. Knife enters food at right angles to the cutting board. Meat should be sliced against the grain and fish with the grain. Slices should be bite-sized or smaller.

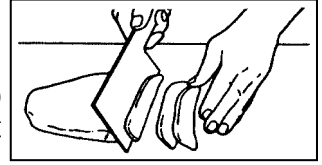

Slicing

Shredding

Shredding is cutting of meat and vegetables into 1/4 inch slices — stacking them up and slicing again.

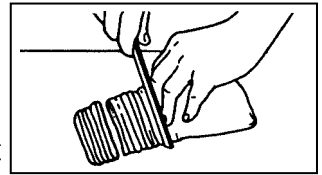

Shredding

Match Stick

Sliced food is cut into long thin strips about 2 inches wide and then chopped into match sticks.

Diagonal Slice

Diagonal slicing is used to reduce fibrous texture food, such as celery and flank steak. The knife enters food on a 45° angle, cutting the food on a slant to increase surface area for cooking.

Chopping

Chopping can be finely or coarsely done. Foods, such as carrots, chicken and onion, are cut into 1/2 to 1 inch pieces.

Dicing

Dicing is used for vegetables such as onions, green peppers and celery. First cut the vegetables into strips and then slice vertically through the strips.

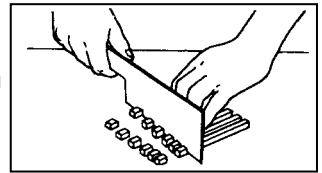

Dicing

Mincing

Mincing is very fine dicing. The pieces should be about 1/16 inch square. Garlic and fresh ginger are common foods that are frequently minced.

Smashing

This crushes garlic or ginger using the flat side of a cleaver. After being smashed, the clove can be minced.

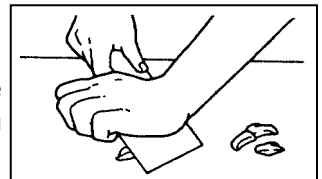

Smashing

STIR FRYING

Stir frying is a rapid method of cooking food in a small amount of oil over high heat at 375°F (190°C). The ingredients are stirred continuously.

It is important to preheat the Wok to the correct temperature before adding oil and food. The hot oil seals in the natural juices in meats and seafood preserving flavor and nutrients. Stir frying produces crisp-tender, brightly colored vegetables.

Using the wooden utensils, constantly stir, lift and toss one food at a time. As items are cooked, they may be stored up the sides of the Wok or placed in separate dishes prior to combining. Repeat this step until all food has been cooked. The preparation of ingredients and preconditioning should be done ahead of time because stir frying takes only minutes. Foods should be thinly sliced, shredded or diced into small uniform pieces, allowing them to cook quickly and evenly. *A dish prepared in this manner should be cooked just before serving.*

STEAMING

Steaming is a common method of Asian cooking. Food is cooked in its own juices by steam over boiling water. Steaming is a healthy way to prepare food. The moist heat retains the food's nutrients, heightens the flavor, preserves the color and minimizes shrinkage.

Steamer Racks may be purchased at many hardware, kitchenware, or general merchandise stores. Bamboo steaming racks work very well. A stainless steel folding steamer is recommended for use in your Toastmaster TWK45 Wok. Do not use sharp-edged metal steaming racks as they will scratch the surface.

Place the Steamer Rack into the Wok. Add water to the Wok so that it is one inch below the Rack. Place the food to be steamed directly on the Rack, or place the food in a heat proof dish and then onto the Rack. Food must never be in the boiling water. Place Wok Cover onto Wok. Set Temperature Control Knob to 250°F (125°C) and cook according to recipe. Add hot water to maintain steaming.

WARNING: This unit produces heat and escaping steam. Use extreme caution when removing or lifting the Lid while cooking.

RED STEWING

Red stewing or *hung tsau*, is the Chinese way to slow cooking. The meat is browned, then simmered from 1 to 4 hours using a large quantity of soy sauce and other seasonings. This method of cooking will produce a tender piece of meat smothered in a rich, brown gravy.

BRAISING/SIMMERING

Braised food is sautéed in a small amount of oil and then cooked in a liquid at a low simmering point until the liquid is reduced to a sauce. Braising meat, fish or firm vegetables produce tender, flavored and moist results.

Many different meats are prepared in this manner including many western dishes and Japanese *sukiyaki*.

Simmering, called for in many recipes, is cooking in liquid just below the boiling point where bubbles form at a slow rate. The temperature setting at which food will simmer in the Wok will vary according to the liquid being used and volume of food being prepared. The difference in altitude may also affect the simmer temperature.

Here's how to find the simmer setting: Follow the recipe directions. Boil at 250°F. Then turn down the Temperature Control Knob until the Indicator Light just goes out. This is the simmer point. Cover and simmer food for the necessary length of time. During the cooking cycle, the Indicator Light will go on and off, indicating the Wok is maintaining the proper temperature for simmering.

SUGGESTIONS FOR EASIER WOK COOKING

1. Read recipe carefully and gather all necessary ingredients before beginning to cook. Advance preparation of food is very important in Asian cuisine.
2. Slice vegetables into small, uniform pieces or slices.
3. Place meat in freezer for about 1 hour before slicing to make slicing easier.
4. Peanut oil is an excellent choice for stir frying because it can be heated to a high temperature without smoking. Any good vegetable oil is suitable. Never use shortening, butter, margarine or olive oil.
5. Pour oil into Wok using a circular motion so that oil flows down sides. This coats the sides in preparation for stir frying.
6. Cook ingredients in sequence, those with longest cooking times added first. (See Blanching Section.)
7. Always mix cornstarch in a small amount of water before adding to Wok.
8. In hard water areas, a film may appear on the Wok surface when steaming. To remove, simply add 1 cup vinegar and 1 quart water to Wok. Turn Temperature Control Knob to 250°F (125°C) and boil for 5 minutes. Turn Control Knob to "OFF" and let cool. Rinse Wok. Repeat if necessary.
9. Never cover Wok when heating oil.

NOTE: Always dry foods to remove excess water. This will prevent the oil from splashing.

SIMPLE GARNISHES

Once you begin Asian cooking, you will want to make the most of each dish by adding attractive food decorations. Here are a few suggestions:

Celery Tassels

Wash the celery stalks and cut into approximately 2 inch lengths. Cut lengthwise at narrow intervals nearly to the base. Leave celery tassel in a bowl of cold water to curl.

Scallion Brushes

Using scallions, cut green stalks in approximately 2 inch lengths. Cut down the lengths at narrow intervals to just half way. Turn and cut from other side. Leave in a bowl of cold water to curl.

Radish Roses

Make 6 to 8 cuts lengthwise through the radish from the heart of the stalk. Place in cold water until they open like flowers.

Twists

Oranges, lemons, and cucumbers can be easily twisted. Thinly slice fruits or vegetables. Cut each slice through the center. Then twist the two halves in opposite directions.

Carrot Curls

Using a potato peeler, peel carrots wafer thin. Twist the slices and fasten with a toothpick. Place in a bowl of cold water to curl.

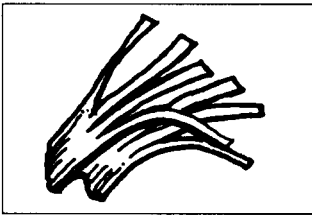

Celery Tassels

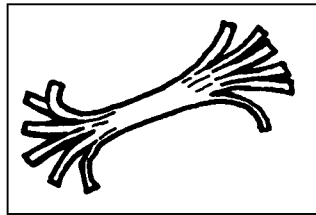

Scallion Brush

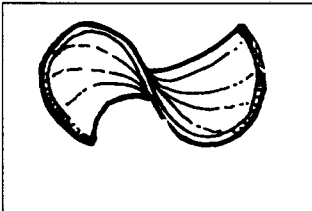

Orange Twist

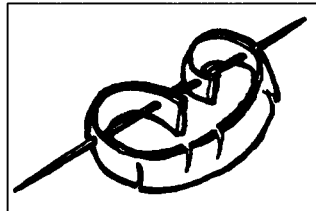

Carrot Curl

GLOSSARY OF ASIAN INGREDIENTS

Asian ingredients are available at most supermarkets, Asian grocery stores, specialty food stores, certain gourmet shops and food sections of department stores.

Baby Corn

Yellow miniature ears of corn 1-1/2 to 2 inches long. Available in cans and packed in water. Used in soups and stir fried dishes.

Bamboo Shoots

Crunchy and juicy bamboo shoots come in cans either sliced, shredded or whole.

Bean Curd (fresh)

(Also called tofu) is a staple in Asian diets — made from fresh soybeans. Use it in sauces, salads, stir fried dishes and soups.

Bean Sprouts

Grown from mung beans. Available fresh or in cans. The crunchy white sprout has a green cap and small tail. Sprouts can be eaten fresh or cooked for less than a minute to preserve crispness. Use in salads, stir fried dishes, etc.

Bok Choy

Chinese cabbage. Has a broad white celery-like stalk and deep green crinkled leaves. It is used in salads, stir fried dishes or as a decorative vegetable.

Chinese Parsley (fresh coriander)

Bright green herb with a pungent flavor used as a staple in Asian cooking or as a garnish.

Egg Roll Wrappers

Dough that is rolled thinly into 7 inch squares. Wrappers are available fresh or frozen.

Ginger Root

Aromatic spiced root, used as a seasoning.

Mushrooms

Enoki Mushrooms — Creamy white, long-stemmed Japanese mushrooms.

Dried Black Mushrooms — Aromatic with a woody taste.

Straw Mushrooms — Crunchy texture used in stir fried dishes.

Snow Peas (Snow Pea Pods)

Bright green peas with edible pods. Used in stir fried dishes.

Water Chestnuts

Crunchy nutty texture, available fresh or in cans. Used in meat and vegetable dishes.

SAUCES AND CONDIMENTS

This is a partial listing of the popular sauces and spices that are traditionally used to enhance the flavor of Asian food.

Soy Sauce

Soy sauce is the fundamental seasoning in all Asian cooking — it contains caramel and sugar. Thin or light soy sauce is saltier than dark soy sauce. They are both used in stir-fried dishes, marinades and as a dipping sauce.

Chili Oil

Oil flavored with hot peppers.

Five Spice Powder

Cocoa-colored, ready mixed blend of five ground spices — anise seed, fennel, clove, cinnamon, ginger or pepper.

Hoisin Sauce

Reddish brown sauce used as a marinade for meats and as a dipping sauce.

Oyster Sauce

Pungent brown sauce used as a seasoning, marinade or a dipping sauce.

Plum Sauce

Sweet and spicy, used commonly with rib and duck dishes or as a dipping sauce.

Rice Vinegar

White or golden, with a sharp flavor.

Sesame Seeds

Small, flat oval seeds with a nutty flavor. Toasting brings out the flavor.

Sesame Oil

Golden brown oil made from toasted sesame seeds used to flavor foods.

Star Anise

(Chinese Anise) Star-like brown pod with a licorice aroma.

Szechwan Brown Peppercorns

Hollow brown peppercorns — very aromatic and have a numbing effect.

STEAMING TIME CHART

Approximate cooking time in minutes for steaming vegetables, seafood, fish, fruits and meat. This chart is only intended as a guide. Adjust time to suit your taste.

Vegetables

Artichokes	18 - 20
Asparagus:	
whole, frozen	8 - 12
canned	7 - 10
Beans (string)	
fresh	7 - 10
frozen	10 - 12
canned	8 - 10
Beets, sliced	6 - 8
Broccoli	6 - 8
Brussels Sprouts:	
fresh, frozen	10 - 12
canned	8 - 10
Cabbage:	
quartered-small	10 - 15
chopped	6 - 8
Cauliflower:	
quartered, small	10 - 15
frozen	8 - 10
Celery	6 - 8
Corn-on-the-Cob:	
fresh, frozen, canned	5 - 6
Green Peppers, sliced	6 - 9
Mushrooms:	
whole	14 - 16
slices	6 - 8
Onions:	
small, whole	6 - 8
Peas:	
fresh, canned	6 - 8
frozen	10 - 12
Potatoes, small, whole	14 - 18
Spinach:	
fresh, frozen	8 - 10
canned	7 - 10
Sauerkraut	6 - 8
Tomatoes, sliced	4 - 5
Zucchini, sliced	5 - 7

STEAMING TIME CHART (CON'T.)

Seafood and Fish

Clams	6 - 9
Oysters	6 - 9
Lobster	8 - 10
Red Snapper	8 - 10
Salmon	8 - 10
Shrimp, peeled	5 - 7

Fruit

Apples, small	12 - 15
Apricots	10 - 12
Pears	12 - 15
Peaches	12 - 15

Meat

Beef Sausage	8 - 10
Beef, sliced thin	18 - 20
Chicken, sliced	20 - 24
Hot Dogs, fresh	5 - 8
Hot Dogs, frozen	6 - 9
Pork Sausage	8 - 10

RECIPES

FRIED CRAB WON-TONS

Makes 24 won-tons

Filling:

2 oz. cooked crabmeat or cooking shrimp

1-3 oz. package cream cheese, softened

1/2 teaspoon Worcestershire sauce

Salt and pepper to taste

24 won-ton wrappers

1 egg, beaten

3 cups vegetable oil

In a small bowl, thoroughly combine filling ingredients. Set aside. Heat oil in Wok at 400°F. Place a level teaspoon of filling in center of wrapper. Fold to form a triangle. Lightly brush center of triangle with beaten egg, bring corners together forming another triangle.

Fry 3 won-tons at a time, approximately 2 minutes or until golden. Remove with a slotted spoon. Drain on paper towels. Serve with mustard and dipping sauces.

ORIENTAL STYLE RIBS

Makes 25 to 35 pieces

3 lb. rack of pork backribs — cut lengthwise, then across in thirds
1 cup chicken broth
8 tablespoons soy sauce
7 tablespoons brown sugar
2 scallions, chopped

Heat the Wok at 350°F. In a small bowl, combine broth, soy sauce and sugar. Set aside. Brown ribs on all sides a few at a time. Remove with wire strainer or slotted spoon, pausing over the Wok to let excess fat drain.

When all ribs have been cooked, return to Wok. Lower Temperature Control Knob to simmer. Pour in liquid mixture. Sprinkle with scallions. Cook covered for 30 minutes, or until liquid is reduced and thick. Serve with hot mustard and plum sauce.

STIR FRIED BEEF WITH ASPARAGUS & PEA PODS

Makes 4 to 6 servings

10 dried black mushrooms
1 cup warm water
1/2 lb. beef flank steak
1 lb. asparagus
1/2 lb. pea pods

Marinade:

1 tablespoon oil
1 teaspoon cornstarch
1 teaspoon sugar
2 teaspoons soy sauce
Salt and pepper to taste

Sauce:

3 tablespoons oil
1 teaspoon fresh ginger root,
finely chopped
2 tablespoons dry white wine
1/2 cup chicken broth
2 scallions (white part only),
finely chopped

Cornstarch mixture:

1/4 cup chicken broth
2 tablespoons cornstarch
2 tablespoons oyster sauce
1 teaspoon sugar

In a bowl, soak dried mushrooms about 20 minutes until soft. Remove and drain. Discard stems and chop into small pieces. Trim excess fat from flank steak. Cut beef against grain into 2-inch strips.

NOTE: Beef will slice easier when it is slightly frozen.

In a bowl, combine marinade ingredients and toss with beef. Refrigerate and let stand for 20 to 30 minutes. Break off tough ends of asparagus as far down as stalk snaps easily. Cut asparagus in 2-inch pieces. Remove strings from pea pods.

Bring water to boil in the Wok at 250°F. Blanch pea pods and asparagus for 1 minute. (See Blanching Section on page 8.) Remove, drain and set aside. Pour out water.

In another bowl, combine the cornstarch mixture ingredients. Set mixture aside. Heat the Wok at 350°F. Swirl 2 tablespoons of oil into the Wok. Add ginger root, garlic, beef and stir fry. Remove beef from the Wok.

Add 1 tablespoon oil to the Wok, stir fry mushrooms and asparagus. Add wine, cook about 30 seconds, stir in 1/2 cup chicken broth. Heat until mixture begins to bubble. Stir in cornstarch mixture and cook until sauce is thickened, about 20 seconds. Add pea pods and return beef to Wok. Toss and garnish with chopped scallions.

AROMATIC RED-COOKED (HUNG TSAU) BEEF

Makes 4 to 6 servings

2-1/2 lbs. boneless beef (chuck or eye of the round roast)

1 tablespoon oil

1 slice fresh ginger root, crushed

3 cloves garlic, crushed

Sauce:

1/2 cup soy sauce

2 dried hot chili peppers

2 tablespoons sugar

1 cup water

1/3 cup dry sherry

Cut beef into 1 inch cubes. In a bowl, mix together sauce ingredients. Heat Wok at 375°F. Swirl oil into Wok. Stir fry ginger, garlic and beef cubes. Reduce temperature to 225°F. Pour sauce ingredients over meat. Cover and simmer 1-1/2 hours. Uncover, turning meat in liquid. Continue cooking for about 1 hour more or until meat is tender. Remove meat and set aside. Discard ginger, chili peppers and garlic from sauce and pour sauce over beef chunks. Serve hot over rice.

NOTE: Check beef from time to time while it is cooking, add more water as needed. There should be about 2 cups of sauce left in Wok when meat is removed.

MIXED CHINESE VEGETABLES

Makes 4 to 6 servings

1/2 head fresh broccoli
1/2 lb. fresh spinach
1/2 lb. fresh pea pods
4 stalks celery
2 carrots
2 medium onions
1 - 8 oz. can water chestnuts, sliced and drained
1 slice fresh ginger root, crushed
2 scallions
3/4 cup chicken broth
2 tablespoons vegetable oil

Cut broccoli tops into flowerets. Cut broccoli stalks in thin strips 2 inches long. Chop spinach coarsely. Remove strings from pea pods. Cut celery in 1/2 inch diagonal slices. Cut onions in wedges and separate layers. Cut carrots and scallions in thin diagonal slices.

Heat oil in the Wok at 375°F. When the Indicator Light goes off, add broccoli stalks, carrots, onion and ginger. Stir fry 1 minute. Add all remaining vegetables. Toss lightly. Add chicken broth. Toss until vegetables are completely coated. Cook until liquid boils. Cover Wok and cook until vegetables are crisp, yet tender, about 2 to 3 minutes.

SNOW PEAS & STRAW MUSHROOMS

Makes 4 to 6 servings

1 lb. snow peas (in pods)
1 15 oz. can straw mushrooms, drained
2 tablespoons dry sherry
Salt and white pepper to taste
1 teaspoon sugar
1/4 cup peanut oil

Remove strings from pea pods. In a bowl, combine sherry, salt, pepper and sugar. Stir to blend. Set aside.

Heat the Wok at 350°F. Swirl oil into Wok. Add straw mushrooms, stirring constantly for about 1-1/2 minutes. Add snow pea pods, and stir fry. Add sherry mixture and cook about 30 seconds.

BRAISED CABBAGE WITH MUSHROOMS

Makes about 4 to 6 servings

1 lb. Chinese cabbage
2 tablespoons peanut oil
1 green pepper, cut in strips
1 tablespoon soy sauce mixed with 1 teaspoon sugar
4 oz. button mushrooms
1/4 cup water

Wash cabbage and chop coarsely. Heat in Wok at 350°F. Swirl oil in Wok, and stir fry cabbage. Add green pepper and mushrooms. Pour sauce over vegetables. Add water to Wok and cover. Cook 5 to 7 minutes, shaking the Wok occasionally.

CRABMEAT EGG FOO YUNG

Makes 2 to 3 servings

4 eggs
1/2 cup shredded crabmeat
1 cup bean sprouts
1 tablespoon onion, minced
2 tablespoons soy sauce
Salt and pepper to taste
1 tablespoon vegetable oil

In a mixing bowl, beat eggs until frothy. Add crabmeat, sprouts, onions, soy sauce, salt and pepper. Add oil to Wok and heat at 250°F. When Temperature Indicator Light goes out, pour in egg mixture. Push egg mixture to the middle with wooden spatula, allowing the uncooked mixture to flow beneath. When bottom of eggs are golden brown, turn over with spatula. Cook until golden. Slide onto plate. Serve immediately with hot brown sauce. (See recipe below.)

Try these variations:

Beef Egg Foo Yung —

substitute 1/2 cup shredded beef for crabmeat.

Chicken Egg Foo Yung —

substitute 1/2 cup shredded chicken for crabmeat.

Shrimp Egg Foo Yung —

substitute 1/2 cup sliced shrimp for crabmeat.

BROWN SAUCE

Makes about 1 cup

2 tablespoons soy sauce
2 teaspoons sugar
2 tablespoons scallions, chopped
1 teaspoon oyster sauce
1 teaspoon dry sherry
1 cup chicken broth
2 tablespoons flour
2 tablespoons vegetable oil

Pour oil into the wok and heat to 225°F. When the Temperature Indicator Light goes off, stir in flour. Add broth in a steady stream, stirring continually. Add remaining ingredients while stirring. Cook until gravy consistency is reached.

FRIED BANANAS

Makes 4 to 6 servings

1-1/2 cups all purpose flour
1 teaspoon baking powder
1/4 teaspoon baking soda
1/4 teaspoon salt
3/4 cup water
4 to 5 firm bananas
3 cups vegetable oil

In a large bowl, combine flour, baking powder, soda and salt. Gradually blend in water, beating with whisk until smooth.

Peel bananas. Cut each banana on the diagonal into 3 to 4 pieces. Heat oil in the Wok at 400°F (200°C). Coat each banana piece by dipping in flour-water mixture. Gently lower several pieces of banana one at a time into oil using a strainer or slotted spoon. Cook bananas in oil until golden brown, about 3 to 5 minutes. Remove and drain on paper towels.

SERVICE INFORMATION

Please refer to warranty statement to determine if in-warranty service applies. This appliance must be serviced by a Toastmaster authorized service center. Unauthorized service will void warranty. Consult your phone directory under "Appliances-Household-Small-Service and Repair," or call 1-800-947-3744 in the U.S. and Canada, 52-5-397-2848 in Mexico.

If an authorized service center is not available locally, your appliance may be returned postage prepaid to our National Service Center at the address shown on the back of this book.

Products must be adequately protected to avoid shipping damage. Surround your appliance with three inches of protective padding and include a copy of your dated sales receipt and a note explaining the problem you have experienced. We recommend insuring your package. No CODs accepted.

KEEP DATED SALES RECEIPT FOR WARRANTY SERVICE.

Keep this booklet. Record the following for reference:

Date purchased _____

Model number _____

Date code (stamped on bottom) _____

LIMITED ONE-YEAR GUARANTEE

Toastmaster Inc. warrants this product, to original purchaser, for one year from purchase date to be free of defects in material and workmanship.

This warranty is the only written or express warranty given by Toastmaster Inc. This warranty gives you specific legal rights. You may have other rights which vary from state to state. ANY OTHER RIGHT WHICH YOU MAY HAVE, INCLUDING ANY IMPLIED WARRANTY OF MERCHANTABILITY OR FITNESS FOR A PARTICULAR PURPOSE IS LIMITED IN DURATION TO THE DURATION OF THIS WARRANTY.

Defective product may be brought or sent (freight prepaid) to an authorized service center listed in the phone book, or to Service Department, Toastmaster Inc., 708 South Missouri St., Macon, MO 63552, for free repair or replacement at our option.

Your remedy does not include: cost of inconvenience, damage due to product failure, transportation damages, misuse, abuse, accident or the like, or commercial use. IN NO EVENT SHALL TOASTMASTER INC. BE LIABLE FOR INCIDENTAL OR CONSEQUENTIAL DAMAGES.

Some states do not allow limitations on how long an implied warranty lasts, or allow the exclusion or limitation of incidental or consequential damages, so the above limitations or exclusions may not apply to you.

For information, write Consumer Claims Manager, at the Macon address. Send name, address, zip, telephone area code and daytime number, model, serial number, and purchase date.

EVERYBODY EATS. It's a fact of life.

**But sometimes preparing
meals can become a chore.**

**That's why TOASTMASTER has been invited
into millions of kitchens just like yours
so we can HELP YOU MASTER your
mixing, baking, grilling, toasting,
brewing, heating and serving
tasks WITH EASE AND STYLE.**

**The TOASTMASTER name stands for a
CELEBRATION of INNOVATION designed
to serve your life and keep you
COOKIN' IN STYLE.**